

Accessories Miniature Relay PT

- Easy replacement of relays on a densely packed DIN rail
- No reduction of protection class or creepage/clearance with plastic retainer
- Plug-in indicator- and protection modules
- Retainer clip with ejection function for relays of 29 mm height
- DIN-rail sockets and accessories: RoHS compliant (Directive 2002/95/EC)



F0263-F

Premium socket with screwless terminals for DIN rail mounting

PT 78 74P Premium socket, logical terminal arrangement, 4 pole
PT 78 72P Premium socket, logical terminal arrangement, 2 pole

- PT 2/4 pole 6/12 A
- Screwless Clamps
- Mounting of solid wires without tool
- Double Clamps per terminal
- Jumper links for interconnection
- Open coil circuit for active modules
- Logical terminal arrangement



F0300-B

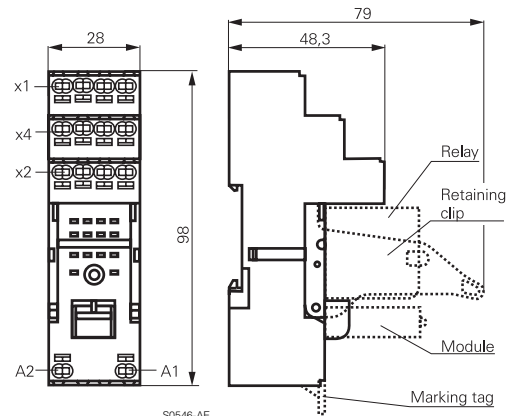

S0546-AE

Approvals

VDE REG.-Nr. 115719, c UL us E135149

| Technical data | 2-pole | 4-pole |
|---|-----------------------|-----------------------|
| Rated voltage / max. switching voltage AC | 240 / 400 VAC | 240 VAC |
| Rated current | 12 A | 6 A |
| Limiting continuous current | see derating curve | |
| Dielectric strength coil-contact circuit | 2500 V _{rms} | 2500 V _{rms} |
| open contact circuit | 1200 V _{rms} | 1200 V _{rms} |
| adjacent contact circuits | 2500 V _{rms} | 2000 V _{rms} |
| Clearance / creepage coil-contact circuit | ≥ 4/4 mm | ≥ 4/4 mm |
| adjacent contact circuits | ≥ 3.5/9.5 mm | ≥ 1.8/3.5 mm |
| Material group of insulation parts | IIIa | |
| Insulation to IEC 60664-1 | | |
| Type of insulation coil-contact circuit | basic | |
| open contact circuit | functional | |
| adjacent contact circuits | basic | |
| Rated insulation voltage | 250 V | |
| Pollution degree | 2 ¹⁾ | |
| Rated voltage system | 230 / 400 V | |
| Overvoltage category | III | |

Derating curve PT787.P

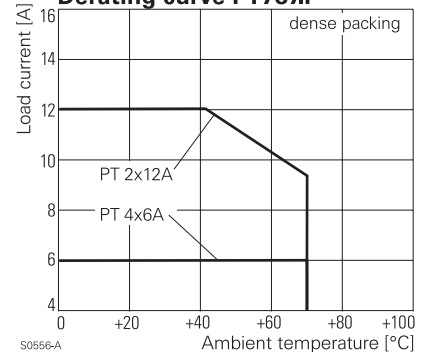

S0556-A

¹⁾ with inserted relay pollution degree 1 in region of contact pins / socket inlets.

Accessories Miniature Relay PT (Continued)

| Technical data (Continued) | 2-pole | 4-pole |
|--|---|--------|
| RoHS - Directive 2002/95/EC | compliant | |
| Ambient temperature range for mounting/handling in operation | -25...+70°C -40...+70°C | |
| Terminals | screwless | |
| Wire strip length | 12 mm | |
| Wire cross section | | |
| solid wire | 1 x 0.75/1.5 mm ² 2 x 0.75/1 mm ² 2 x 1.5 mm ² | |
| with standard isolation (no oversize isolation) | 2 x 1.5 mm ² | |
| stranded wire | | |
| without bootlace crimp | 1 x 0.75/1.5 mm ² 2 x 0.75/1 mm ² 2 x 1.5 mm ² | |
| without bootlace crimp with standard isolation | 2 x 1.5 mm ² | |
| with bootlace crimp | 1 x 0.75/1 mm ² 2 x 0.75 mm ² | |
| with bootlace crimp without isolation or isolation min 18 mm long | 1 x 1.5 mm ² | |
| For stranded wires with braids 0.05 mm or smaller the use of bootlace crimps is recommended. When using stranded wires without bootlace crimp the clamp must be opened during insertion. | | |
| Insertion cycles | A (10) | |
| Max. Insertion Force total | 100 N | |
| Mounting distance | ≥ 0, dense packing | |
| Weight | 44 g | 60 g |
| Packaging unit | 10 pcs | |

| Socket with screwless terminals for DIN rail mounting | | |
|---|--|-------------|
| Type | | Part Number |
| PT 7872P | Premium socket, logical terminal arrangement Socket with screwless terminals 2 pole | 1860100-1 |
| PT 7874P | Premium socket, logical terminal arrangement Socket with screwless terminals 4 pole | 1860000-1 |

| Accessories for PT 78 72P, PT 78 74P | | |
|--------------------------------------|---|-------------|
| Type | | Part Number |
| PT 17 021 | Plastic retaining clip, relay height 29 mm | 2-1415526-1 |
| PT 28 800 | Metal retaining clip PT, relay height 29 mm | 5-1419111-9 |
| PT 17 040 | Marking tag | 6-1415037-1 |
| PT 17 0P1 | Jumper link, max load 12 A | 1860214-1 |

How to use, Precautions

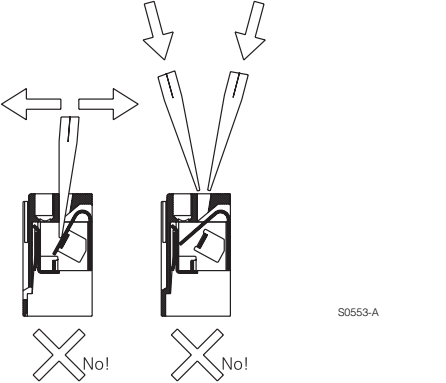
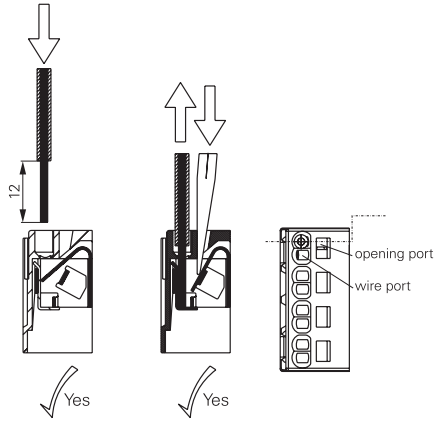
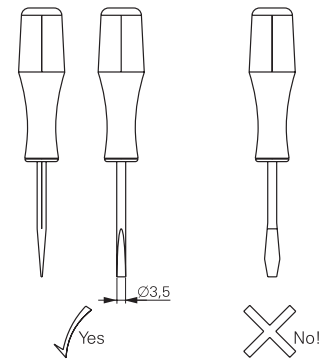

Jumper link

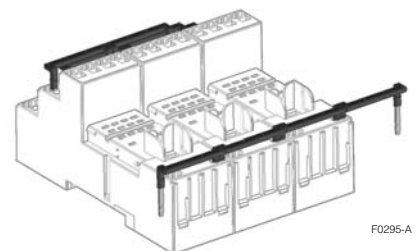

When connecting more than 2 poles with staggered jumper bars the lower bars need to be stripped and shortened to an appropriate length to enable correct fitting.

Accessories Miniature Relay PT (Continued)

PT DIN-rail socket with screw type terminals PT 78 722 / PT 78 742

- Socket with logical arrangement of control/load terminals
- High quality rising clamp terminals
- Captive combination terminal screws
- Second A2 for easier looping
- Jumper bars for interconnection



F0264-C

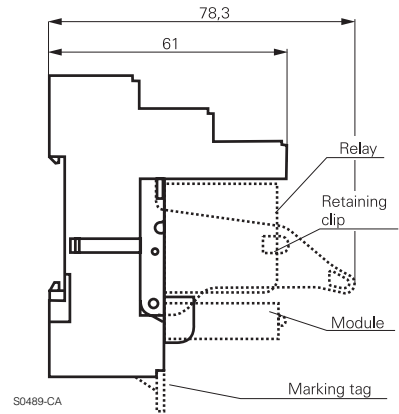
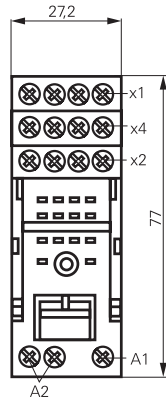

S0489-CA

Approvals

VDE REG.-Nr. 115719, c UL us E135149

| Technical data | 2-pole | 4-pole |
|---|-------------------------|-----------------------|
| Rated voltage / max. switching voltage AC | 240 / 400 VAC | 240 VAC |
| Rated current | 12 A | 6 A |
| Limiting continuous current | see derating curve | |
| Dielectric strength coil-contact circuit | 2500 V _{rms} | 2500 V _{rms} |
| open contact circuit | 1200 V _{rms} | 1200 V _{rms} |
| adjacent contact circuits | 2500 V _{rms} | 2000 V _{rms} |
| Clearance / creepage coil-contact circuit | ≥ 4 / 4 mm | ≥ 4 / 4 mm |
| adjacent contact circuits | ≥ 3.5 / 9.5 mm | ≥ 1.8 / 3.5 mm |
| Material group of insulation parts | IIIa | |
| Insulation to IEC 60664-1 | | |
| Type of insulation coil-contact circuit | basic | |
| open contact circuit | functional | |
| adjacent contact circuits | basic | |
| Rated insulation voltage | 250 V | |
| Pollution degree | 2 ¹⁾ | |
| Rated voltage system | 230 / 400 V | |
| Overvoltage category | III | |
| RoHS - Directive 2002/95/EC | compliant | |
| Ambient temperature range | -40...+70°C | |
| Terminals | screw | |
| Terminal screw torque acc. IEC 61984 | 0.5 Nm | |
| max. | 0.7 Nm | |
| Wire cross section | | |
| single wire | 2 x 2.5 mm ² | |
| fine wire | 2 x 2.5 mm ² | |
| with bootlace crimp (DIN 46228/1) | 2 x 1.5 mm ² | |
| Insertion cycles | A (10) | |
| Max. Insertion Force total | 100 N | |
| Mounting distance | ≥ 0, dense packing | |
| Weight | 44 g | 60 g |
| Packaging unit | 10 pcs | |

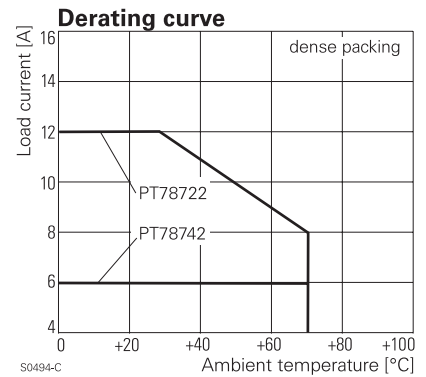

S0494-C

¹⁾ with inserted relay pollution degree 1 in region of contact pins / socket inlets.

Accessories Miniature Relay PT (Continued)

| DIN-rail socket with screw type terminals, In/Out arrangement | | |
|---|--|-------------|
| Type | | Part Number |
| PT 78 722 | DIN-rail socket with screw type terminals, In/Out arrangement 2 pole | 1415526-1 |
| PT 78 742 | DIN-rail socket with screw type terminals, In/Out arrangement 4 pole | 1-1415526-1 |

Jumper bar

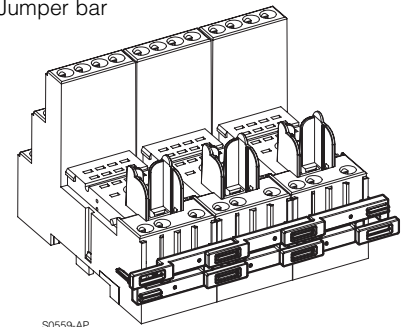

| Accessories for PT 78 722, PT 78 742 | | |
|--------------------------------------|--|-------------|
| Type | | Part Number |
| PT 17 021 | Plastic retaining clip, relay height 29 mm | 2-1415526-1 |
| PT 28 800 | Metal retaining clip PT, relay height 29 mm | 5-1419111-9 |
| PT 17 040 | Marking tag | 6-1415037-1 |
| PT 17 0R6 | Jumper bar, max load 12 A for connection of up to 6 PT sockets | 1860517-5 |

PT DIN-rail socket with screw type terminals PT 78 720/730/740/741

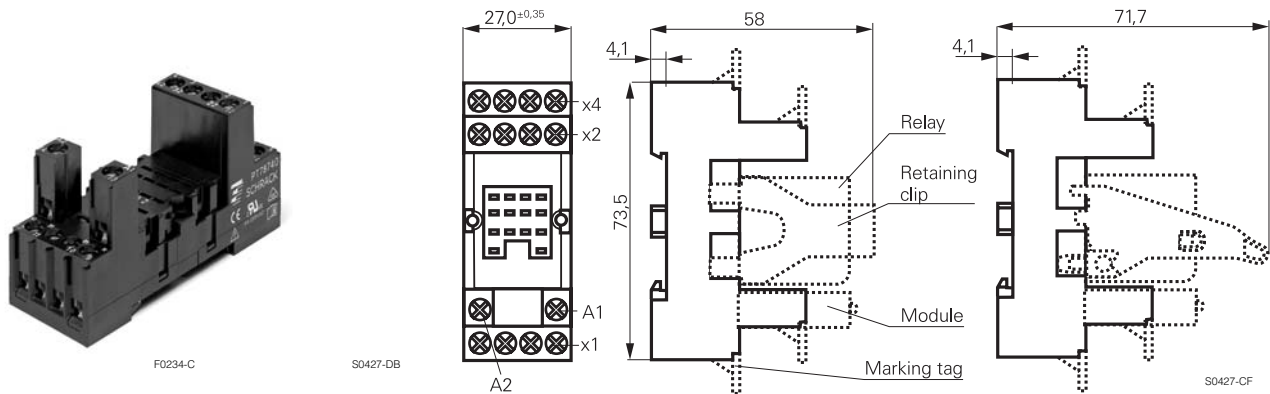

Approvals

VDE REG.-Nr. 115719, c **UL** us E135149

| Technical data | 2-pole | 3-pole | 4-pole |
|---|-------------------------|-----------------------|-----------------------|
| Rated voltage / max. switching voltage AC | | 240 / 400 VAC | |
| Rated current | 12 A | 10 A | 6 A |
| Limiting continuous current | see derating curve | | |
| Dielectric strength coil-contact circuit | 2500 V _{rms} | 2500 V _{rms} | 2500 V _{rms} |
| open contact circuit | 1200 V _{rms} | 1200 V _{rms} | 1200 V _{rms} |
| adjacent contact circuits | 2500 V _{rms} | 2500 V _{rms} | 2000 V _{rms} |
| Clearance / creepage coil-contact circuit | ≥ 4/4 mm | ≥ 4/4 mm | ≥ 4/4 mm |
| adjacent cont. circuits | ≥ 3.5/9.5 mm | ≥ 2.6/3.5 mm | ≥ 1.8/3.5 mm |
| Material group of insulation parts | IIIa | | |
| Insulation to IEC 60664-1 | | | |
| Type of insulation coil-contact circuit | basic | basic | basic |
| open contact circuit | functional | functional | functional |
| adjacent contact circuits | basic | basic | functional |
| Rated insulation voltage | 250 V | | |
| Pollution degree | 2 | | |
| Rated voltage system | 230 / 400 V | | |
| Overvoltage category | III | | |
| RoHS - Directive 2002/95/EC | compliant | | |
| Ambient temperature range | -40...+70°C | | |
| Terminals | screw | | |
| Terminal screw torque acc. IEC 61984 | 0.5 Nm | | |
| max. | 0.7 Nm | | |
| Wire cross section | | | |
| single wire | 2 x 2.5 mm ² | | |
| fine wire | 2 x 2.5 mm ² | | |
| with bootlace crimp (DIN 46228/1) | 2 x 1.5 mm ² | | |

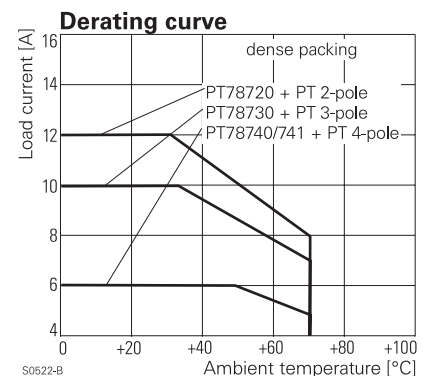

Accessories Miniature Relay PT (Continued)

| Technical data (Continued) | 2-pole | 3-pole | 4-pole |
|----------------------------|--------|--------------------|--------|
| Insertion cycles | | A (10) | |
| Max. Insertion Force total | | 100 N | |
| Mounting distance | | ≥ 0, dense packing | |
| Weight | 41 g | 48 g | 55 g |
| Packaging unit | | 10 pcs | |

DIN-rail socket with screw type terminals

| Type | | Part Number |
|------------------|---|-------------|
| PT 78 720 | DIN-rail socket with screw type terminals, 2 pole | 6-1415034-1 |
| PT 78 730 | DIN-rail socket with screw type terminals, 3 pole | 9-1415071-1 |
| PT 78 740 | DIN-rail socket with screw type terminals, 4 pole | 4-1415033-1 |
| PT 78 741 | DIN-rail socket with screw type terminals, 4 pole package with protection diode module A1+, A2- | 5-1415034-1 |

Accessories for PT 78 720, PT 78 730, PT 78 740, PT 78 741

| Type | | Part Number |
|------------------|--|-------------|
| PT 17 016 | Plastic retaining clip PT, relay height 29 mm | 5-1415037-1 |
| PT 17 024 | Plastic retaining clip PT with ejecting function, relay height 29 mm | 1816124-1 |
| PT 28 800 | Metal retaining clip PT, relay height 29 mm | 5-1419111-9 |
| PT 17 040 | Marking tag | 6-1415037-1 |
| PT 17 0R6 | Jumper bar, max load 12 A for connection of up to 6 PT sockets | 1860517-5 |

LED- and Protection Modules for PT 78 72P, PT 78 74P, PT 78 722, PT 78 742, PT 78 720, PT 78 730, PT 78 740

Easy insertion of module into the socket
Wiring in parallel to the coil

| Type | | Part Number |
|-------------------|--|-------------|
| PTM T0 0A0 | EM09 Protection diode (standard, A1+, A2-) | 9-1415036-1 |
| PTM T0 0L0 | EM01 Protection diode (A1-, A2+) | 1415037-1 |
| PTM U0 524 | EM02 RC-network 6...60 VAC | 1-1415037-1 |
| PTM U0 730 | EM03 RC-network 110...230 VAC | 2-1415037-1 |
| PTM V0 524 | EM04 Varistor 24 VAC | 3-1415037-1 |
| PTM V0 615 | EM13 Varistor 115 VAC | 6-1415365-1 |
| PTM V0 730 | EM05 Varistor 230 VAC | 4-1415037-1 |
| PTM R0 730 | EM29 Bleeder Resistor 110...230 VAC | 1-1415539-2 |

LED

| | | |
|-------------------|--|-------------|
| PTM L0 024 | EM18 red LED 6...24 VDC w. prot.diode (std, A1+, A2-) | 5-1415036-1 |
| PTM G0 024 | EM12 green LED 6...24 VDC w. prot.diode (std, A1+, A2-) | 2-1415036-1 |
| PTM L1 024 | EM08 red LED 6...24 VDC w. prot. diode (A1-, A2+) | 8-1415036-1 |
| PTM L0 060 | EM16 red LED 24...60 VDC w. prot.diode (std, A1+, A2-) | 5-1415539-3 |
| PTM G0 060 | EM25 green LED 24...60 VDC w. prot.diode (std, A1+, A2-) | 7-1415539-7 |
| PTM L0 110 | EM19 red LED 60...110 VDC w. prot. diode (A1+, A2-) | 2-1415392-1 |
| PTM G0 110 | EM26 green LED 60...110 VDC w. prot diode (A1+, A2-) | 1-1415539-7 |
| PTM L0 220 | EM27 red LED 110...220 VDC w. prot. diode (A1+, A2-) | 1-1415539-4 |
| PTM G0 220 | EM28 green LED 110...220 VDC w. prot diode (A1+, A2-) | 1-1415539-6 |
| PTM L0 524 | EM07 red LED 6...24 VDC/VAC | 6-1415036-1 |
| PTM G0 524 | EM11 green LED 6...24 VDC/VAC | 3-1415036-1 |
| PTM L0 560 | EM14 red LED 24...60 VDC/VAC | 1-1415539-3 |
| PTM G0 560 | EM30 green LED 24...60 VDC/VAC | 1-1415539-5 |
| PTM L0 730 | EM06 red LED 110...230 VAC | 7-1415036-1 |
| PTM G0 730 | EM10 green LED 110...230 VAC | 4-1415036-1 |

Relay Packages

Complete packages consisting of a relay mounted on a socket: see Relay Package PT

PT17 016

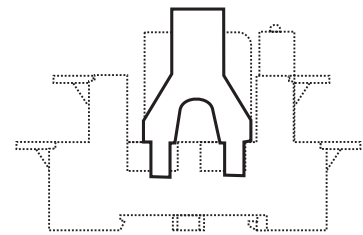

S0427-CH

PT17 024

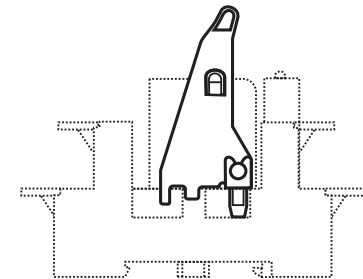

S0427-CI

Marking tags

- White marking area 28 x 6 mm
- Snaps on socket in up to 4 positions



F0231-A



F0232-A

Accessories Miniature Relay PT (Continued)

PT sockets for PCB mount and with solder terminals

PT 78 600, socket with solder terminals, 4-pole



F0132-A

S0308-AA

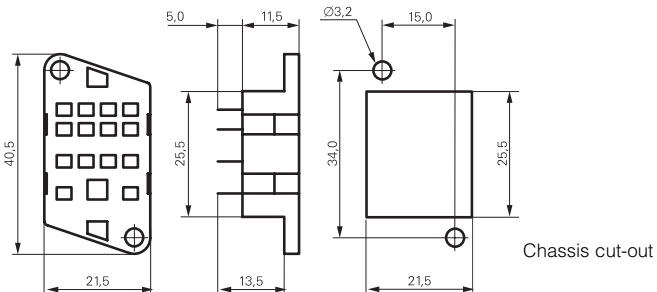

Chassis cut-out

PT 78 602, PT 78 603, PT 78 604, socket with PCB terminals, 2-, 3- and 4-pole



F0133-A

S0308-AB

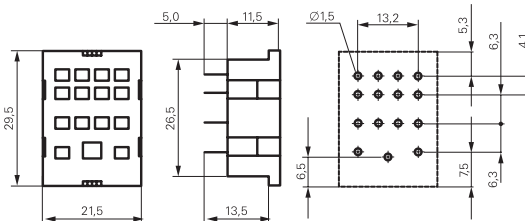

PT 78 601, socket with solder terminals, 4-pole



F0134-A

S0308-AC

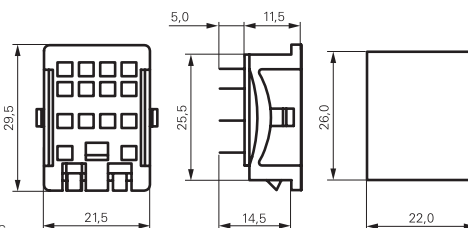

Chassis cut-out

| Technical data | 2-pole | 3-pole | 4-pole |
|---|-----------------------|-----------------------|-----------------------|
| Rated voltage / max. switching voltage AC | | 240 / 400 VAC | |
| Rated current | 12 A | 10 A | 6 A |
| Dielectric strength coil-contact circuit | 2500 V _{rms} | 2500 V _{rms} | 2500 V _{rms} |
| open contact circuit | 1200 V _{rms} | 1200 V _{rms} | 1200 V _{rms} |
| adjacent contact circuits | 2500 V _{rms} | 2500 V _{rms} | 2000 V _{rms} |
| Clearance / creepage coil-contact circuit | ≥ 4/4 mm | ≥ 4/4 mm | ≥ 4/4 mm |
| adjacent cont. circuits | ≥ 3.5/9.5 mm | ≥ 2.6/3.5 mm | ≥ 1.8/3.5 mm |
| Material group of insulation parts | | IIIa | |
| Insulation to IEC 60664-1 | | | |
| Type of insulation coil-contact circuit | basic | basic | basic |
| open contact circuit | functional | functional | functional |
| adjacent contact circuits | basic | basic | functional |
| Rated insulation voltage | | 250 V | |
| Pollution degree | | 2 | |
| Rated voltage system | | 230 / 400 V | |
| Overtoltage category | | III | |

Accessories Miniature Relay PT (Continued)

| Technical data (Continued) | 2-pole | 3-pole | 4-pole |
|------------------------------|---|--------|--------|
| RoHS - Directive 2002/95/EC | compliant as per product date code 0517 | | |
| Ambient temperature range | -40...+80°C | | |
| Terminals | pcb, solder terminals | | |
| Insertion cycles | A (10) | | |
| Max. Insertion Force total | 100 N | | |
| Mounting distance | ≥ 0, dense packing | | |
| Resistance to soldering heat | 270°C / 10 s | | |
| Weight | 6 g | 7 g | 7 g |
| Packaging unit | 25 pcs | | |

| PT sockets | | |
|------------------|--------------------------------------|-------------|
| Type | | Part Number |
| PT 78 600 | Socket with solder terminals, 4 pole | 4-1415043-1 |
| PT 78 602 | Socket with PCB terminals, 2 pole | 5-1415043-1 |
| PT 78 603 | Socket with PCB terminals, 3 pole | 1393162-5 |
| PT 78 604 | Socket with PCB terminals, 4 pole | 3-1415043-1 |
| PT 78 601 | Socket with solder terminals, 4 pole | 6-1415043-1 |

| Accessories for PT 78 600, PT 78 601, PT 78 602, PT 78 603, PT 78 604 | | |
|---|---|-------------|
| Type | | Part Number |
| PT 28 802 | Metal retaining clip PT, relay height 29 mm | 1393162-1 |